

NOTES:

1. FOR GRAVITY APPLICATIONS ONLY.
2. ALL UNITS ARE MANUFACTURED WITH FIBERGLASS REINFORCED PLASTICS. PHYSICAL CHARACTERISTICS AND THICKNESS: POLYESTER RESIN AND E GLASS MINIMUM THICKNESS 1/4" WALL AND 3/8" TOP AND BOTTOM BOWLS. MINIMUM BURIAL DEPTH = 18" FOR NON TRAFFIC RATED AND MINIMUM BURIAL DEPTH = 30" FOR TRAFFIC RATED MAXIMUM BURIAL DEPTH = 6 FT 8 IN. (GRADE TO INVERT OF INLET) FOR DEEPER INSTALLATIONS CALL GREEN TURTLE FOR CUSTOM REINFORCEMENT.
3. ALL UNITS ARE TO BE INSTALLED IN ACCORDANCE WITH THE MANUFACTURERS INSTALLATION INSTRUCTION.
4. STANDARD PIPE STUBS ARE SOCKET SDR 35 PVC SEWER MATERIAL (SCHEDULE 40 ADAPTORS ADDED FOR ALL PROJECTS IN USA).
5. EHT 50 - 300 UNITS COME STANDARD WITH 4" INLET (OTHER CUSTOM SIZES AVAILABLE AT EXTRA CHARGE).
6. EXTENSION COLLAR TO BE ORDERED TO MEET FINISHED GRADE. CUT ON SITE FOR FINAL ADJUSTMENT AND CAULKED WITH SIKAFLEX BY CONTRACTOR IF WATERTIGHT SEAL REQUIRED.
7. COVERS AVAILABLE FOR H2O TRAFFIC LOADING, PEDESTRIAN LOADING OR ABOVE GROUND INSTALLATION.
8. CONSULT GREEN TURTLE FOR OTHER SIZES.
9. ALL UNITS ARE FACTORY TESTED.
10. 30 YEAR WARRANTY AGAINST LEAKS, AND STRUCTURAL FAILURE.

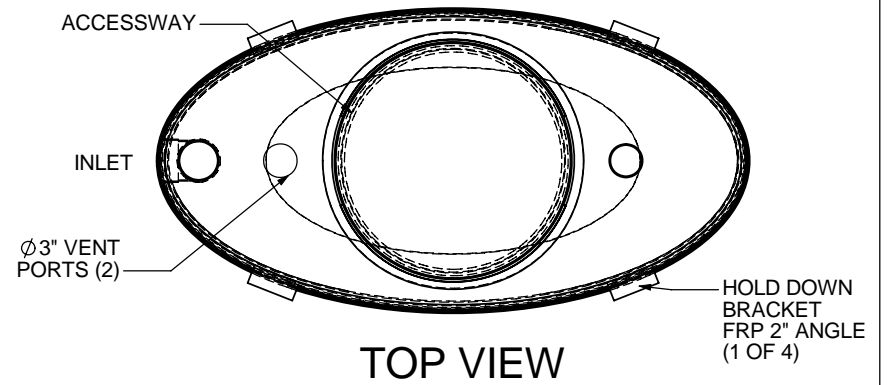

TOP VIEW

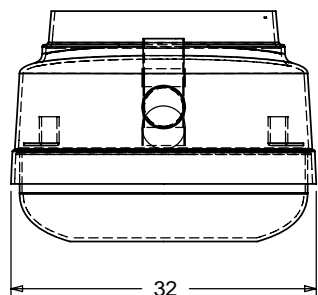

SIDE VIEW

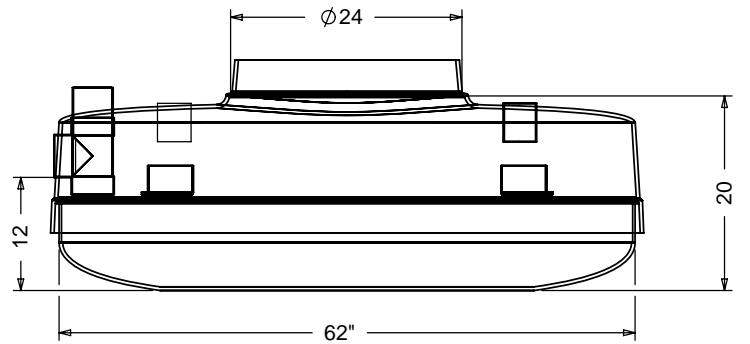

FRONT VIEW

TITLE: HOLDING TANK EHT 50 USG FIBERGLASS TANK 4" INLET 24" MANWAY ALL DIMENSIONS IN INCHES		REV 1 2 3 4 5 6 7 8 9 10	DATE APRIL 24, 2007 APRIL 23, 2008 	DRAWN L. SIMKINS L. SIMKINS 	greenturtle TM 877 428 8187 US 877 966 9444 CAN www.greenturtletech.com
PROJECT: WO:		SCALE: A DWG. NO.: EHT 50 REV.: 4			
<input checked="" type="checkbox"/> OPTIONS: HIGH LEVEL SENSOR		DRAWN BY: F CHANDLER DRAWN DATE: 9/14/04		SCALE: 1:20 DO NOT SCALE DRAWING	SHEET 1 OF 1